

**Robust H_{∞} Tracking Control Combined
with Optimized PSS by PSO Algorithm
for Multimachine Power System**

In this paper, the proposed controller design is based on H_{∞} tracking control combined with the optimized Power System Stabilizer (PSS). In addition the parameters of the PSS controller are optimized using the Particle Swarm Optimization algorithm (PSO). The aim of this study is to obtain a high performance for the speed deviation and the angle rotor simultaneously, also the damping of the oscillations and the enhancing power system stability. Using the H_{∞} tracking control show the convergence of the errors to the neighborhood of zero. In order to test the effectiveness of the proposed method, the simulation results clearly indicate the damping of the oscillations of the angle rotor and angular speed with reduced overshoots which confirms the performance of the proposed scheme.

Keywords: H_{∞} tracking control; power system stabilizer; particle swarm optimization algorithm; multi machine power system.

Article history: Received 23 May 2014, Received in revised form 26 September 2014, Accepted 27 December 2014

1. Introduction

Generally, power systems are nonlinear and the operating conditions can vary over a wide range. In recent years, signal stability of power systems has received much attention. The main reasons for this are the increasing size of generating units, the loading of transmission lines, and the use of high speed excitation systems near their limit [1].

The stability limit of multimachine power systems can be extended by PSS, which enhances the damping of the oscillations associated with electromechanical modes [2]. Due to the frequent changes in operating point, such as heavy load change or system topology change following a major disturbance, this type of PSS are often found to be inadequate mainly because of the fixed parameter settings of the conventional PSS [3]. Since power systems are highly nonlinear, conventional fixed parameter PSS cannot cope with great changes in the operating condition during normal operation [3]. That is why, it is necessary to use the most efficient optimization methods to simplify the problem and to find the optimal values of PSS controller.

Many successful and powerful optimization methods and algorithms have been employed in formulating and solving this problem [4]. This paper proposes Particle Swarm Optimization (PSO) to enhance Power System Stabilizer (PSS). PSO algorithm is an intelligent optimization algorithm imitating the bird swarm behaviors, which was proposed by psychologist Kennedy and Dr. Eberhart in [5]. Compared with other optimization algorithms such as Genetic Algorithms (GA), Chaotic Optimization Algorithm

* Corresponding author: Faiza Dib, Department of physics, LESSI Laboratory, Faculty of Science, Sidi Mohamed Ben Abdellah University, Dhar Elmahrez, Fez, Morocco, Email: dib.fayza@yahoo.fr

¹ Department of Physics, LESSI Laboratory, Faculty of Science, Sidi Mohamed Ben Abdellah University, Dhar Elmahrez, Fez, Morocco

(COA) and Neuro-Fuzzy System(NFS) [6]. The PSO algorithm is applied for optimal tuning PSS parameters problem in order to reduce the PSS design effort and find the best possible solution.

In the last decade, H_∞ optimal control theory has been well developed and found extensive application to efficiently treat the robust stabilization and disturbance rejection problems [7]. The H_∞ control performance for uncertain nonlinear systems is proposed to attenuate the effects caused by the disturbances and the approximate errors. The H_∞ tracking control has a simplified structure, regulate the output amplitude of the angle rotor and the angular speed deviation to a desired value, and reduce the oscillations [8].

In this paper, the control law used is composed by nonlinear robust H_∞ tracking controller combined with the equivalent control of the system and the PSS optimized by the particle swarm optimization algorithm. The objective of this work is to guarantees the enhancing the stability of the system and also to compensate the fluctuations of oscillation in the of multimachine power system.

This paper is organized as follows. Section 3 describes the mathematical dynamic model of a multimachine power system. The PSS based on PSO algorithm is described in Section 4. Section 5 designs the nonlinear H_∞ tracking control combined with the optimized PSS for a multimachine power system. In Section 6 simulation results of a three-machine nine-bus power system illustrate the effectiveness of the proposed design method. Finally, conclusion is given in Section 7.

2. Notation

δ	Rotor angle
ω	Rotor speed (pu)
$\Delta\omega$	Speed deviation
P_m	Mechanical input power
P_e	Electrical output power (pu)
M	System inertia (Mj/MVA)
E'_q	Internal voltage behind x'd (pu)
E_{fd}	Equivalent excitation voltage (pu)
X'_d	Transient reactance of d axis (pu)
X_q	Steady state reactance of q axis (pu)
X_d	Steady state reactance of d axis (pu)
T'_{do}	Time constant of excitation circuit (s)
T	Simulation time (s)
T_w	Washout filter (s)
$T_1 - T_4$	Time constants of lead-lag dynamic compensator (s)
K	Gain of the Stabilizer
PSS	Power System Stabilizer
PSO	Particle Swarm Optimization

3. Multimachine power system model:

Under some standard assumptions, the dynamics of n interconnected generators through a transmission network can be described by classical model with flux decay dynamics. The

network has been reduced to internal bus representation assuming loads to be constant impedances and considering the presence of transfer conductance. The dynamical model of the i^{th} machine is represented by the classical third order model [9].

$$\begin{aligned}\dot{\delta}_i &= \omega_i - \omega_s \\ \dot{\omega}_i &= \frac{\omega_s}{2H_i} (Pm_i - D_i (\omega_i - \omega_s) - E'_{qi} I_{qi}) \\ \dot{E}'_{qi} &= \frac{1}{T'_{di}} (E_{fi} - E'_{qi} - (X_{di} - X'_{di}) I_{di})\end{aligned}\quad (1)$$

Where

$$\begin{cases} I_{qi} = G_{ii} E'_{qi} + \sum_{j=1, j \neq i}^n E'_{qi} \{G_{ij} \cos(\delta_j - \delta_i) - B_{ij} \sin(\delta_j - \delta_i)\} \\ I_{di} = -B_{ii} E'_{qi} - \sum_{j=1, j \neq i}^n E'_{qi} \{G_{ij} \sin(\delta_j - \delta_i) + B_{ij} \cos(\delta_j - \delta_i)\} \end{cases}\quad (2)$$

I_{qi} and I_{di} represent currents in d-q reference frame of the i^{th} generator, E'_{qi} is the transient EMF in the quadrature axis, $E_{fi}(t)$ is the equivalent EMF in the excitation coil, X_{di} and X'_{di} are direct axis reactance and direct axis transient reactance, respectively; Pm_i is the mechanical input power assumed to be constant, D_i is the damping factor; all parameters are in p.u. H_i , represents the inertia constant, in seconds; T'_{di} is the direct axis transient short circuit time constant, in seconds; δ_i is the rotor angle, in radians; ω_i represents the relative speed, $\omega_s = 2\pi f$ is the synchronous machine speed, in rad/s; G_{ij} and B_{ij} are the i^{th} row and j^{th} column element of the nodal conductance matrix and nodal susceptance matrix respectively, which are symmetric, at the internal nodes after eliminating all physical buses in p.u.. We consider $E_{fi}(t)$ as the input of the system [8].

The state representation of the i^{th} machine of a multimachine power system can be written in the following form: $x_i = [x_{i1}, x_{i2}, x_{i3}]^T = [\delta_i, \omega_i, E'_{qi}]$ for $i = 1, 2, \dots, n$, represents the state vector of i^{th} subsystem, and the control applied is given by

$$u_i = \frac{1}{T'_{di}} E_{fi} \quad (3)$$

$$\begin{aligned}\dot{x}_{i1} &= x_{i2} \\ \dot{x}_{i2} &= f_{i1}(X) \\ \dot{x}_{i3} &= f_{i2}(X) + u_i\end{aligned}\quad (4)$$

Where

$$\begin{cases} f_{i1}(X) = a_i - b_i x_{i2} - c_i x_{i3}^2 - d_i x_{i3} \sum_{j=1, j \neq i}^n x_{j3} \{G_{ij} \cos(x_{j1} - x_{i1}) - B_{ij} \sin(x_{j1} - x_{i1})\} \\ f_{i2}(X) = -e_i x_{i3} + h_i \sum_{j=1, j \neq i}^n x_{j3} \{G_{ij} \sin(x_{j1} - x_{i1}) + B_{ij} \cos(x_{j1} - x_{i1})\} \end{cases}\quad (5)$$

And

$$a_i = \frac{\omega_s}{2H_i} Pm_i ; b_i = \frac{\omega_s}{2H_i} D_i ; c_i = \frac{\omega_s}{2H_i} G_{ii}$$

$$d_i = \frac{\omega_s}{2H_i} ; e_i = \frac{(1 - (X_{di} - X'_{di})B_{ii})}{T'_{di}} ; h_i = \frac{X_{di} - X'_{di}}{T'_{di}}$$

4. Power System Stabilizer based on Particle Swarm Optimization algorithm

The Optimization algorithms are another area that has been receiving more attention in the past few years in the research as well as in the industry. An optimization algorithm is a numerical method or algorithm for finding the maxima or the minima of an objective function with certain constraints [10]. In PSO algorithm, the population has n particles that represent candidate solutions. Each particle is an m dimensional real valued vector where m is the number of optimized parameters. Therefore each optimized parameter represents a dimension of the problem space [11].

4.1. Objective function

The fitness function evaluates the performance of particles to determine whether the best fitting solution is achieved. During the execution, the fitness of the best individual improves over time and typically tends to stagnate towards the end of the execution. Ideally, the stagnation of the process coincides with the successful discovery of the global optimum [10]. The following equations give the present velocity and position vectors:

$$v_{j,g}^{t+1} = wv_{j,g}^t + c_1r_1(pbest_{j,g} - x_{j,g}^t) + c_2r_2(gbest_g - x_{j,g}^t) \quad (6)$$

$$x_{j,g}^{t+1} = x_{j,g}^t + v_{j,g}^{t+1} \quad (7)$$

For $j=1, 2 \dots n$ and $g=1, 2 \dots m$.

Where n is the number of particles in the swarm; m is the number of components for the vectors $v_{j,g}$ and $x_{j,g}$, t is the number of generation (iteration); $v_{j,g}^t$ is the g^{th} component of the velocity of particle j at iteration t . c_1 and c_2 are two positive constants, called cognitive and social parameters respectively. r_1 and r_2 are random numbers, uniformly distributed in (0, 1). $x_{j,g}^t$ is the g^{th} component of the position of particle j at iteration t ; $pbest_j$ is the $pbest$ of particle j ; $gbest$ is the $gbest$ of the group [12].

w is the inertia weight, which produces a balance between global and local explorations requiring less iteration on average to find a suitably optimal solution. It is determined by the following equation:

$$w = w_{\max} - \frac{w_{\max} - w_{\min}}{iter_{\max}} iter \quad (8)$$

Where w_{\max} is the initial weight, w_{\min} is the final weight, $iter$ is the current iteration number, is the maxi-mum iteration number.

4.2. PSS design using PSO

The transfer function of the PSS is as given below [13]:

$$U_{pssi}(s) = K_i \frac{sT_{wi}}{1+sT_{wi}} \left(\frac{(1+sT_{1i})(1+sT_{3i})}{(1+sT_{2i})(1+sT_{4i})} \right) \Delta\omega_i(s) \quad (9)$$

Where $K = PSS$ gain

T_{wi} = Washout Time constant.

$T_{1i}, T_{2i}, T_{3i}, T_{4i}$ = Time constants

Time Constants $T_{1i} = T_{3i}, T_{2i} = T_{4i}$ are Identical Phase Compensator Block.

PSS is designed to minimize the power system oscillations after a small or large disturbance so as to improve the power system stability. These oscillations are reflected in the deviations in the power angle, rotor speed and line power. Minimization of any one or all of the above deviations could be chosen as an objective function. The PSS parameters consisting of the time constants T_1 to T_4 and the gain K need be optimally chosen for each generator to guarantee optimal system performance under various system configurations and disturbances [14].

The PSS controller is optimized by minimizing the objective function (J) in order to improve the system response in terms of oscillation and settling time. Despite there are several methods to come up with the improvement of the performance of the control system [15], such as integral of squared error (ISE), integral of time weighted squared error (ITSE), integral of absolute error (IAE) and integral of time weighted absolute value of error (ITAE):

$$J_{ISE} = \int_0^T \Delta\omega^2(t) dt \quad (10)$$

$$J_{IAE} = \int_0^T |\Delta\omega(t)| dt \quad (11)$$

$$J_{ITAE} = \int_0^T t |\Delta\omega(t)| dt \quad (12)$$

$$J_{ITSE} = \int_0^T t \Delta\omega^2(t) dt \quad (13)$$

In this work, the ISTE of the speed deviation $\Delta\omega$ is used as the fitness function (J) which is determined as:

$$J = \int_0^T \Delta\omega^2(t).t.dt \quad (14)$$

Here $\Delta\omega$ is the error involving Rotor Speed deviation. T represents the Time of Simulation. The objective here is to minimize the objective function J, so that the integral of the squared error deviation is minimized thus enhancing the damping of the low frequency oscillations. The Design problem including the constraints imposed on the various PSS based on PSO parameters is given as follows:

Optimize J

Subject to

$$K_i^{\min} \leq K_i \leq K_i^{\max}$$

$$T_{1i}^{\min} \leq T_{1i} \leq T_{1i}^{\max}$$

$$T_{2i}^{\min} \leq T_{2i} \leq T_{2i}^{\max}$$

Where K_i^{\min} and K_i^{\max} are the lower and upper bounds of gains PSS, T_{ji}^{\min} and T_{ji}^{\max} are the lower and upper bounds of the time constants of all controllers.

The PSS based on PSO technique can be described in the following steps.

The parameters of PSS controller optimized with PSO algorithm are given by:

$$Z_i = [K_i, T_{1i}, T_{2i}]$$

Step 1: Define the problem space and set the acceptable limits of the controller parameters.

Step 2: Initialize an array of particles with random positions and their associated velocities inside the problem space. These particle positions represent the initial set of solutions.

Step 3: Initialize, $pbest$ with a copy of the position for particle, determine $gbest$

Step 4: Change the velocities according to (6).

Step 5: Move each particle to the new position according to (7) and return to Step 3.

Step 6: Evaluate the fitness value of each particle.

Step 7: Compare the current fitness value with the particles previous best value $pbesti$.

If $fitness(Z) < pbest$ then $pbesti = Z_i$

Step 8: Determine the current global minimum among particle's best position.

Step 9: If the current global minimum is better than $gbest$, then assign the current global minimum to $gbest$ and assign the current coordinates to $gbestz$ coordinates.

Step 10: Repeat **Step 3- Step 9** until a stopping criteria is satisfied.

5. The proposed control design

5.1. H_∞ tracking controller

H_∞ Optimal control theory has better disturbance attenuation capability than some robust optimal control theories. Thus, combining the H_∞ control theory with the equivalent control, the effects of the approximation errors, parameter uncertainties and external disturbances on the tracking errors can be reduced to be less than or equal a desired level [16].

Consider the dynamical equation of an n^{th} order nonlinear system described by the following nonlinear differential equation:

$$x^{(n)} = F(x) + G(x)u \quad (15)$$

Where $x = [x, \dot{x}, \dots, x^{(n-1)}] = [x_1, x_2, \dots, x_n]$ is a state vector, $u \in \mathbb{R}$ control input.

$$e_{1i} = \delta_i - \delta_{ir} = x_{i1} - x_{i1r}$$

$$e_{2i} = \dot{e}_{1i} = x_{i2}$$

$$e_{3i} = \dot{e}_{2i} = a_i - b_i x_{i2} - c_i x_{i3}^2 - d_i x_{i3} I_{d_i}$$

For $i=1, 2, 3$. Let the tracking error vector be: $e_i = [e_{1i}, e_{2i}, \dots, e_{ni}] = [e_i, \dot{e}_i, \dots, e_i^{(n-1)}]$

Then our design objective is to impose H_∞ control so that the following asymptotically stable tracking:

$$e_i^{(n)} + k_{n-1}e_i^{(n-1)} + \dots + k_0e_i = 0 \quad (16)$$

In this study the relative degree is $n=3$ then

$$e_i^{(3)} + k_2\ddot{e}_i + k_1\dot{e}_i + k_0e_i = 0 \quad (17)$$

Where $k = [k_0, k_1, k_2, 1]^T$ are the coefficients of the Hurwitz Polynomial:

$$h(\lambda) = \lambda^3 + k_2\lambda^2 + k_1\lambda + k_0 \quad (18)$$

The equivalent control is given by:

$$u_{eq_i} = \frac{1}{G_i(x)} \left(-F_i(x) + \dot{x}_{ir}^{(n)} + k_0e_i + k_1\dot{e}_i + k_2\ddot{e}_i \right) \quad (19)$$

From (17), the output tracking error dynamic equation of nonlinear system (15) is described by:

$$\dot{e}_i = Ae_i + B \left[G_i(x) \cdot (u_{eq_i} - u_{hi}) \right] \quad (20)$$

Where

$$A = \begin{pmatrix} 0 & 1 & 0 & \dots & 0 \\ 0 & 0 & 1 & 0 & \dots & 0 \\ \dots & \dots & \dots & \dots & \dots & \dots \\ -K_0 & -K_1 & -K_2 & \dots & \dots & -K_{n-1} \end{pmatrix}$$

And $B = [0 \ 0 \ \dots \ 1]$

Where u_{hi} is a H_∞ compensator, defined as:

$$u_{hi} = -\frac{1}{G_i(x)r} E_i^T P B \quad (21)$$

Where r is a positive scalar value and $P = P^T > 0$ is the P solution of the following Riccati-like equation [7].

$$PA + A^T P + Q - \frac{2}{r} P B B^T P + \frac{1}{\rho^2} P B B^T P = 0 \quad (22)$$

Remark: The solvability of H_∞ tracking performance is on the existence of positive semi definite and symmetric solution P of which can be rewritten as [17]:

$$PA + A^T P + Q - P B \left(\frac{2}{r} - \frac{1}{\rho^2} \right) B^T P = 0 \quad (23)$$

Where $Q > 0$, ρ is prescribed attenuation level and r is positive constant.

The above Riccati equation has a positive semi definite solution $P = P^T > 0$ if and only if:

$$\frac{2}{r} - \frac{1}{\rho^2} \geq 0 \quad \text{or} \quad 2\rho^2 \geq r \quad (24)$$

5.2. H_∞ tracking controller combined with optimized PSS

Among the problems find in the multimachine power system, there is often the oscillations caused by the nonlinearity of the system, with random choice of parameters of

the PSS controller, which reduces the robustness and stability of the system. to solve these problems and improve the stability, the control law used in this study is composed by three terms, the equivalent control u_{eq_i} , the robust term represented by the H_∞ controller, and $u_{pss_i}^*$ is the regulator PSS optimized by the PSO algorithm. The controller objective of u_{hi} is to obtain high-performance of the tracking and to force the actual output to follow the reference trajectory.

$$u_i = u_{eq_i} + u_{hi} + u_{pss_i}^* \quad (25)$$

$$u_{eq_i} = \frac{1}{G_i(x)} (-F_i(x) + k_0 e_i + k_1 \dot{e}_i + k_2 \ddot{e}_i) \quad (26)$$

$$u_{hi} = -\frac{1}{G_i(x)r_i} E^T P B \quad (27)$$

6. Simulation result

The power system multimachine model involving Three Synchronous Alternators and Nine Bus network represented in figure 1 [18], The parameters of the generators and network used in the simulation were taken from [9], see Table 5.

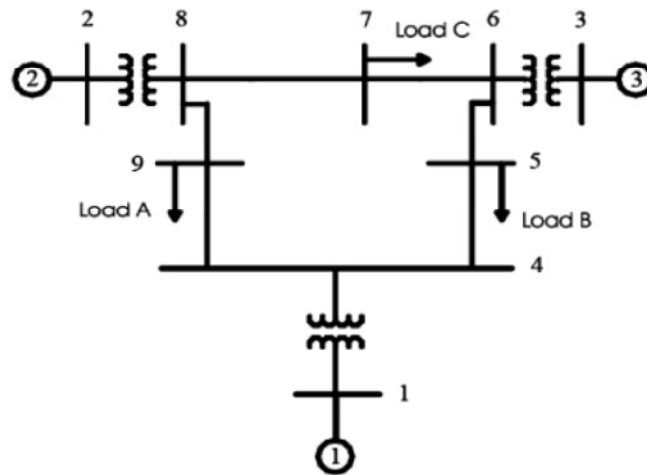

Fig. 1: Three machine nine bus power systems.

With the aim of implementing the controller, the following equilibrium point $X_{ir} = (x_{1ir}, x_{2ir}, x_{3ir}) = [\delta_i \ \Delta\omega_i \ E'_{qi}]$ for $i=1, 2, 3$ of the three-machine system is considered:

$$x_{11r} = 0.0396, x_{12r} = 0, x_{13r} = 1.0566$$

$$x_{21r} = 0.3444, x_{22r} = 0, x_{23r} = 1.0502$$

$$x_{31r} = 0.2300, x_{32r} = 0, x_{33r} = 1.017$$

To demonstrate the performance and the robustness of the proposed method, two performance indices: the Integral of the Time multiplied Absolute value of the Error (ITAE) and integral of time weighted squared error (ISTE) based on the system performance characteristics are being used as:

$$ITAE = \int_0^T t(|\Delta\omega_1| + |\Delta\omega_2| + |\Delta\omega_3|)dt \quad (28)$$

$$ITSE = \int_0^T (\Delta\omega_1^2(t) + \Delta\omega_2^2(t) + \Delta\omega_3^2(t))t.dt \quad (29)$$

Table 1: Performance indices of the controllers

	H_∞ & PSO-PSS control	PSO-PSS control	PSS control
ITAE	0.1383	5.7545	9.6784
ITSE	7.3704e-005	2.9432e-004	9.9515e-004

It is observed that, more than the values of these indices are lower, the response of the system in terms of characteristics in time domain is better. Numerical results of the performance and robustness for all cases are presented in table. 1.

To demonstrate and evaluating the performance of the proposed control, we performed simulation for multimachine power system as in figure 1 with the aim to compare the performance of the conventional PSS, the PSO based on PSS control and the control law proposed in this study composed by the three terms: the equivalent control, the robust term H_∞ and the power system stabilizer optimized by the particle swarm optimization algorithm. The simulation results demonstrated that the proposed controller were capable of guaranteeing the good performance which gives the stability of the multimachine power system.

The specified parameters of the PSS that are used in this study given in table 3 in appendix, the Washout Time constants T_{wi} are fixed at 10. The PSS based on PSO algorithm parameters need to be carefully adjusted. Table 2 in appendix shows the specified parameters for the algorithm PSO that are used in this study. The optimal tuning of three PSS parameters namely, K_i , T_{1i} and T_{2i} is performed by the PSO. Since there are three PSSs, nine parameters need be optimized. The ranges of optimized parameters are given in (32). These limits help in reducing the computational times significantly.

The control parameters and their boundaries are given below:

$$\begin{aligned} 0 < K_i < 70 \\ 0.01 < T_{1i} < 1 \\ 0.01 < T_{2i} < 1 \end{aligned} \quad (30)$$

The control parameters of H_∞ tracking control used are

$$Q_1 = 0.3^* \begin{bmatrix} 1 & 0 & 0 \\ 0 & 1 & 0 \\ 0 & 0 & 1 \end{bmatrix}; r_1 = 0.1; \rho_1 = 0.5, Q_2 = 0.5^* \begin{bmatrix} 1 & 0 & 0 \\ 0 & 1 & 0 \\ 0 & 0 & 1 \end{bmatrix}; r_2 = 0.1; \rho_2 = 0.5$$

$$Q_3 = 0.1 * \begin{bmatrix} 1 & 0 & 0 \\ 0 & 1 & 0 \\ 0 & 0 & 1 \end{bmatrix}; r_3 = 0.1 ; \rho_3 = 0.5$$

The coefficients of the Hurwitz Polynomial used in this study for the multimachine power system are:

$$K_{1i} = 6; K_{2i} = 9; K_{3i} = 1$$

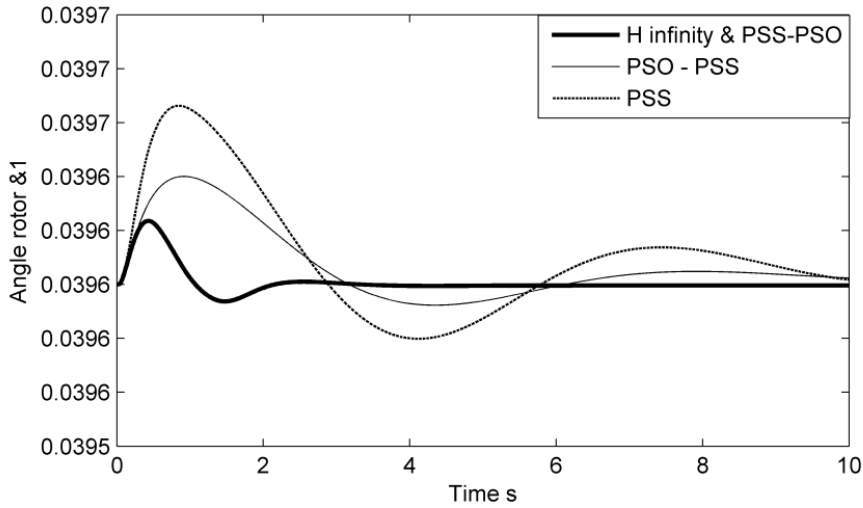

Fig. 2: Angle rotor δ_1

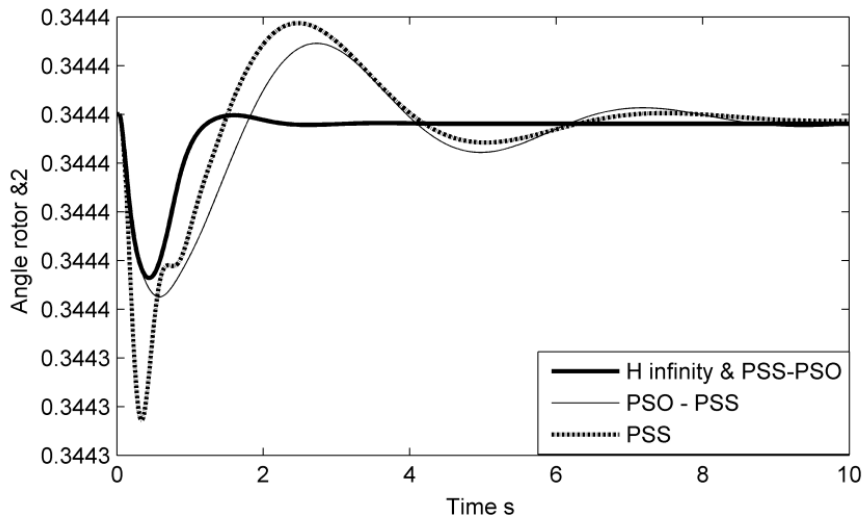

Fig. 3: Angle rotor δ_2

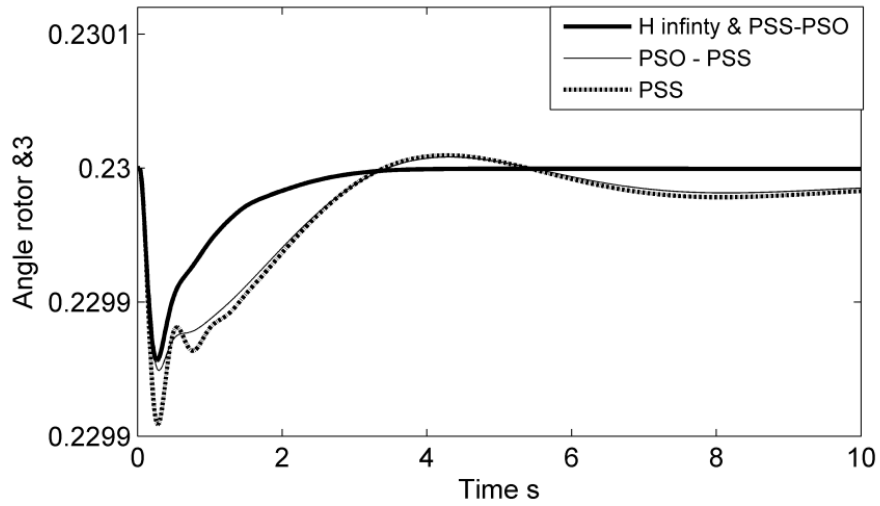

Fig. 4: Angle rotor δ_3

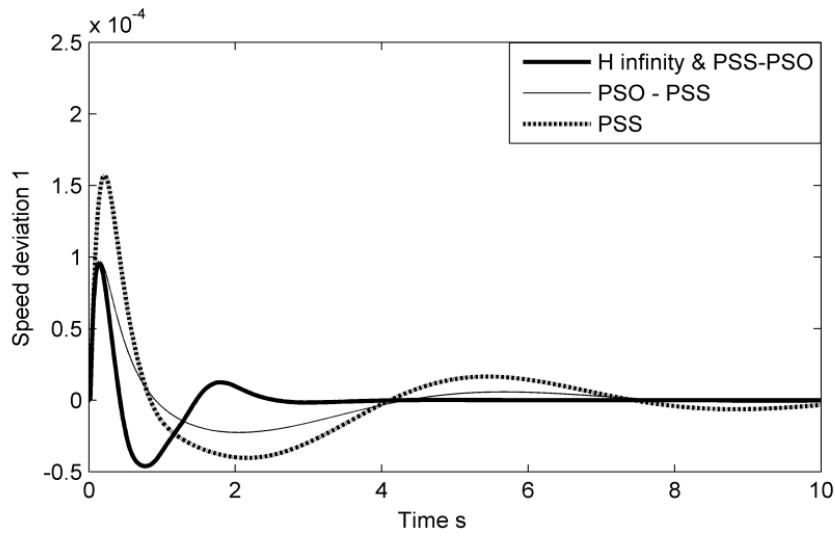

Fig. 5: Speed deviation $\Delta\omega_1$

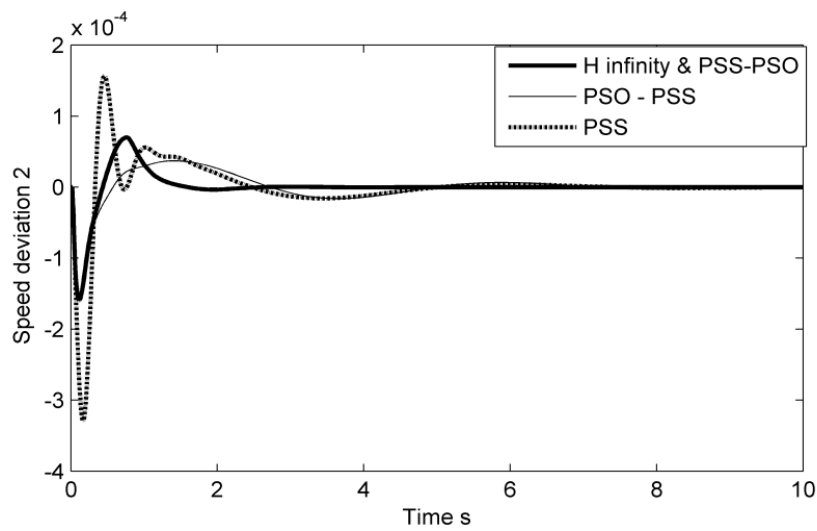

Fig. 6: Speed deviation $\Delta\omega_2$

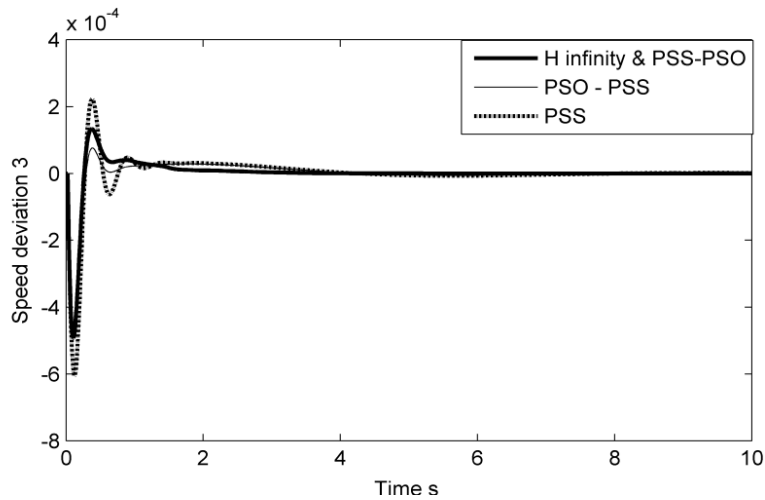

Fig. 7: Speed deviation $\Delta\omega_3$

Implemented results in this section have demonstrated a superior performance of the proposed control in terms of damping the oscillation and enhancing the stability of the system as compared with the PSO based on PSS and the conventional PSS.

With this proposed control, the mechanical variables such as the angles rotor (δ_1 and δ_2) and the deviation speed ($\Delta\omega_1$ and $\Delta\omega_2$) in the two generators (G1 & G2) are stabilized in 2.5 second; see figure 2.3 and Figure 5.6. For the third generator (G3), the angle rotor (δ_3) and the deviation speed ($\Delta\omega_3$) are stabilized in 3 and 2 second, respectively; see figure 4 and figure 7. It is mentionable that the proposed controller was almost damped and reached the steady state value faster than the other controller, the conventional PSS controller requires more time and more oscillations before the same variables are stabilized.

7. Conclusion

In this work, to provide a good performance and to enhance stability for the multimachine power system, an optimal methodology has been developed using the robust H_∞ combined with the PSS optimized by PSO algorithm. The H_∞ controller used is capable of handling the robust stability and guarantee a favorable tracking performance. Then, the particle swarm optimization (PSO) is employed to search for the optimal parameters of the power system stabilizer (PSS). The simulation results show that, the proposed controllers improve the stability performance of the multimachine power system and the oscillations are effectively damped.

8. Appendix

Table 2: Parameters used PSO algorithm

PSO Parameters	Value
Swarm size	25
Iteration-max	100
c_1, c_2	2.0, 2.0
W_{max}, W_{min}	0.9, 0.4

Table 3: Conventional PSS parameters

Parameters	Kp	T1	T2
PSS-1	20.39	0.3	0.9
PSS-2	22.46	0.21	0.7
PSS-3	10.33	0.10	0.5

Table 4: Optimized PSS parameters

Parameters	Kp	T1	T2
PSS-PSO-1	56.2995	0.8423	0.6180
PSS-PSO-2	36.0912	0.2669	0.6707
PSS-PSO-3	46.7172	0.6492	0.8128

Table 5: Nominal parameters values

Parameters	Gen1	Gen2	Gen3
H	23.64	6.4	3.01
X_d	0.146	0.8958	1.3125
X'_d	0.0608	0.7798	0.1813
D	0.3100	0.5350	0.6000
P_m	0.7157	1.6295	0.8502
T'_{do}	8.96	6.0	5.89

References

- [1] D.K. Sambariya & R. Gupta, Fuzzy Applications in a Multi-Machine Power System Stabilizer, *Journal of Electrical Engineering and Technology*, 5(3), 503-510, 2010.
- [2] M. S. Mahmoud & H. M. Soliman, Design of Robust Power System Stabilizer Based on Particle Swarm Optimization, *Circuits and Systems*, 3, 82-89, 2012.
- [3] E.Nechadi, M.N. Harmas, A. Hamzaoui & N. Essounbouli, Type-2 fuzzy based adaptive synergetic power system control, *Electric Power Systems Research, Elsevier*, 88, 9– 15, 2012.
- [4] A. Shrivastava, M. Dubey & Y. Kumar, Optimization Techniques Based Power System Stabilizer's: An Overview, *International Journal on Emerging Technologies*, 4(1), 50-54, 2013.
- [5] J. Kennedy & R. C. Eberhart, Particle swarm optimization. *IEEE International Conference on Neural Network*, 1942-1948, 1995.
- [6] E.Nechadi, M. N. Harmas, N. Essounbouli & A. Hamzaoui, Adaptive Fuzzy Sliding Mode Power System Stabilizer Using Nussbaum Gain, *International Journal of Automation and Computing*, 10(4), 281-287, 2013.
- [7] B. S. Chen, C.H. Lee, & Y. C. Chang, H_∞ tracking design of uncertain nonlinear SISO systems: Adaptive fuzzy approach, *IEEE Transactions on fuzzy systems*, 4(1), 32-43, 1996.
- [8] L. Wenlei & X. L. Peter, Adaptive tracking control of an MEMS gyroscope with H-infinity performance, *Journal of Control Theory and Applications, springer link*, 9(2), 237-243, 2011.
- [9] A. Colbia-Vegaa, J. de Leon-Morales, L. Fridman, O. Salas-Pena & M.T. Mata-Jimenez, Robust excitation control design using sliding-mode technique for multimachine power systems, *Electric Power Systems Research, Elsevier*, 78, 1627-1634, 2008.
- [10] S. M. GirirajKumar, D. Jayaraj & A. R. Kishan, PSO based Tuning of a PID Controller for a High Performance Drilling Machine, *International Journal of Computer Applications*, 1(19), 12-18, 2010.
- [11] M. H. Moradi & M. Abedini, A combination of genetic algorithm and particle swarm optimization for optimal DG location and sizing in distribution systems, *Electrical Power and Energy Systems, Elsevier*, 34, 66-74, 2012.
- [12] H. Shayeghi, A. Safari & H.A. Shayanfar, PSS and TCSC damping controller coordinated design using PSO in multi-machine power system, *Energy Conversion and Management Elsevier*, 51, 2930-2937, 2010.
- [13] K. BenMeziane, F. Dib & I. Boumhidi, Fuzzy sliding mode controller for power system SMIB, *Journal of Theoretical and Applied Information Technology*, 54(2), 331-337, 2013.
- [14] A. Ghasemi, H. Shayeghi & H. Alkhatib, Robust design of multimachine power system stabilizers using fuzzy gravitational search algorithm, *Electrical Power and Energy Systems, Elsevier*, 51, 190-200, 2013.
- [15] A. Khodabakhshian, R. Hemmati, M. Moazzami, Multi-band power system stabilizer design by using CPCE algorithm for multi-machine power system, *Electric Power Systems Research*, 101, 36-48, 2013.
- [16] C. K. Lin, H_∞ reinforcement learning control of robot manipulators using fuzzy wavelet networks, *Fuzzy Sets and Systems, Elsevier*, 160(12), 1765-1786, 2009.
- [17] P. Yongping, Y. Zhou, S. Tairen & J. E. Meng, Composite adaptive fuzzy H_∞ tracking control of uncertain nonlinear systems, *Neurocomputing, Elsevier*, 99, 15-24, 2013.
- [18] P. M. Anderson & A.A.Fouad, Power System Control and Stability, 2nd Edition - A John Wiley & Sons INC. Publication, 2002.

© 2015. This article is published under
<https://creativecommons.org/licenses/by-nc/4.0/>(the “License”).
Notwithstanding the ProQuest Terms and Conditions, you may use this
content in accordance with the terms of the License.